

Counting 1 to 10

Count and write the number of letters in the name of each musical instrument, in the box provided.

Solved Example

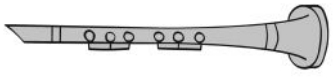

FLUTE

a)

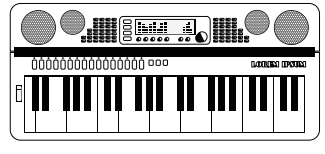

KEYBOARD

b)

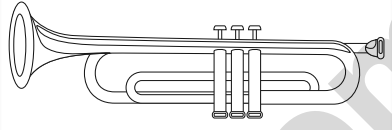

TRUMPET

c)

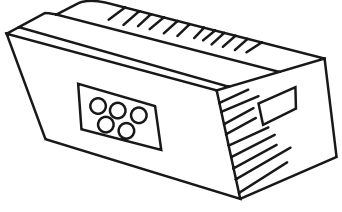

HARMONIUM

d)



DRUM

e)

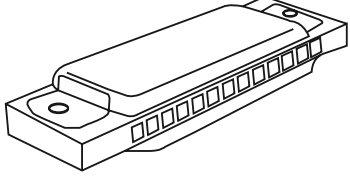

MOUTH ORGAN

f)



GUITAR

g)

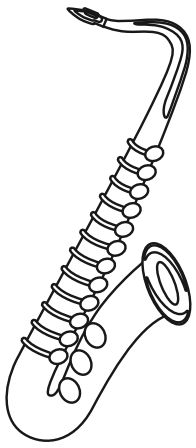

SAX

h)



PIANO

Number Names 1 to 10

Count the total number of black dots on the dice. Write the number name of the total obtained to complete the cross-word.

Example

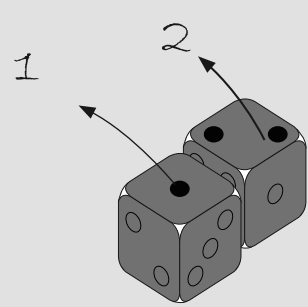

B. 1 and 2 makes three dots
B. Three

Across

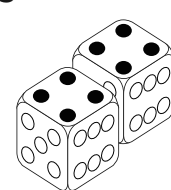
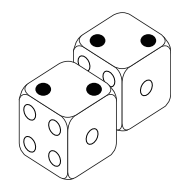
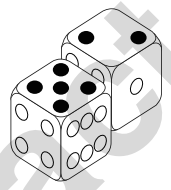
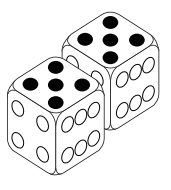
A  C  E  G 

A					B
					T
					H
	C				R
					E
		E	E		F
			G		

Down

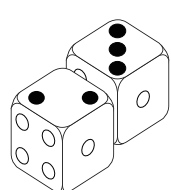
C 

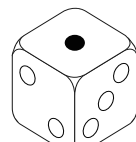
D 

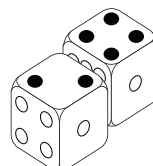
E 

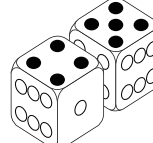
F 

G 